

150 mm Wafer Shipping and Handling Products

The widest selection of 150 mm wafer shipping and handling products available

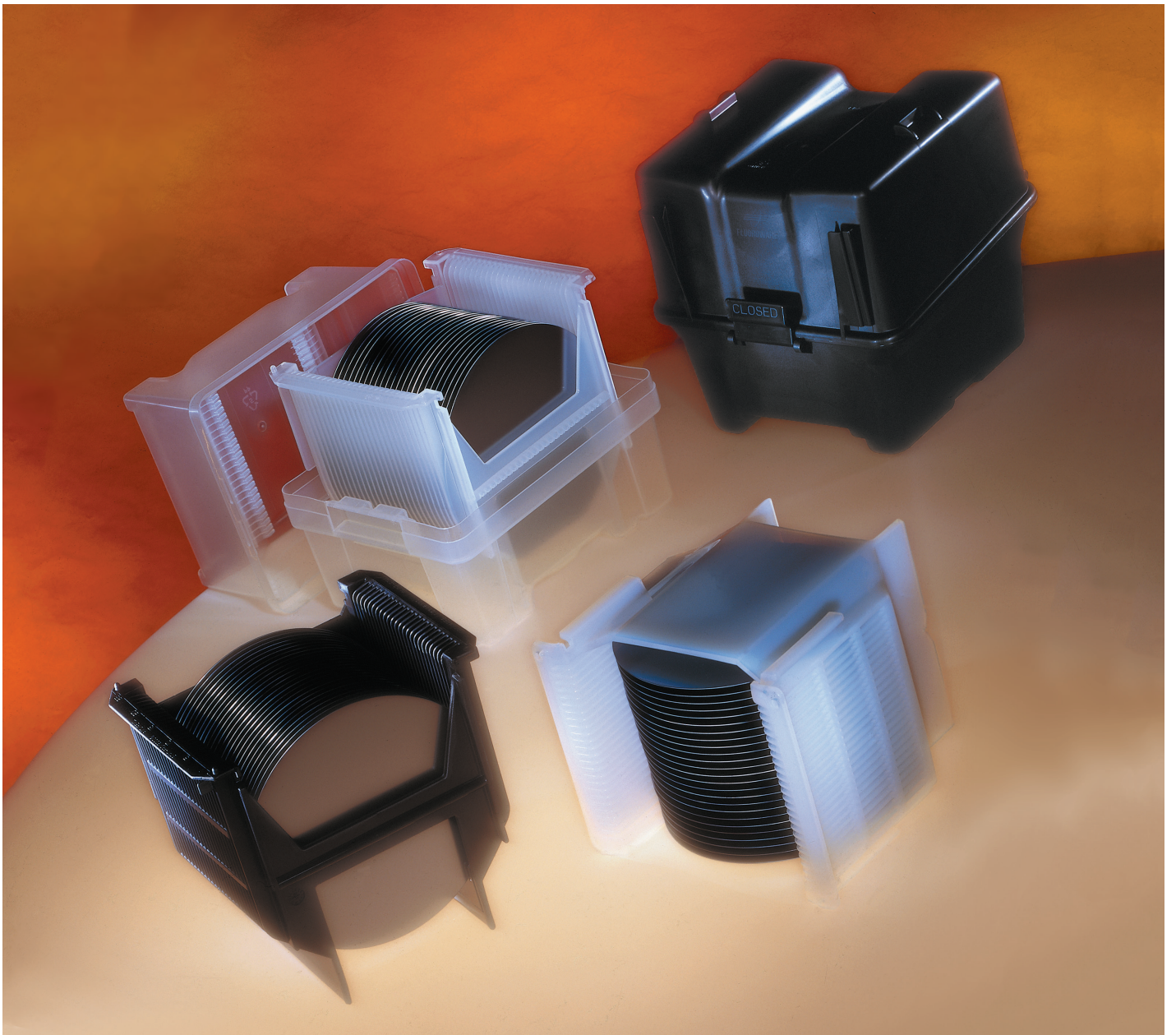

TABLE OF CONTENTS

Advanced Wafer Transport	1	Storage Boxes	10
Multiple Wafer Shipping Boxes	2	E160 Series	10
Ultrapak® Series	2	E124 Series	10
Single Wafer Shipping Boxes and Trays	3	E90 Series	10
H93 Series Shipping Box	3	E206 Series	10
Solopak® Series Shipping Box	4	H3150 Series	11
H22 Series Shipping Box	5	Options and Accessories	12
H20 Series Tray	5	Wafer Carrier Handles	12
Transport Wafer Carriers	6	Storage Box Accessories	13
194/196 Series	6	Identification Options	13
182 Series	6	Material Information	14
Process Wafer Carriers	8	Other Products	15
194 Series	8	Limited Warranty	16
190 Series	8	For More Information	16
182 Series	9	Terms and Conditions of Sale	16

ADVANCED WAFER TRANSPORT

Trends in wafer processing technology have mandated advancements in wafer carrier technology to support today's advanced semiconductor processing facilities. Wafer carriers designed for advanced wafer transport offer dramatic performance benefits over traditional low- and mid-range wafer carriers, including:

- **Precise wafer access** – the wafer is in a precise and predictable location
- **Reliable equipment operation** – on process tools and automated materials handling systems
- **Secure wafer protection** – from contamination and damage

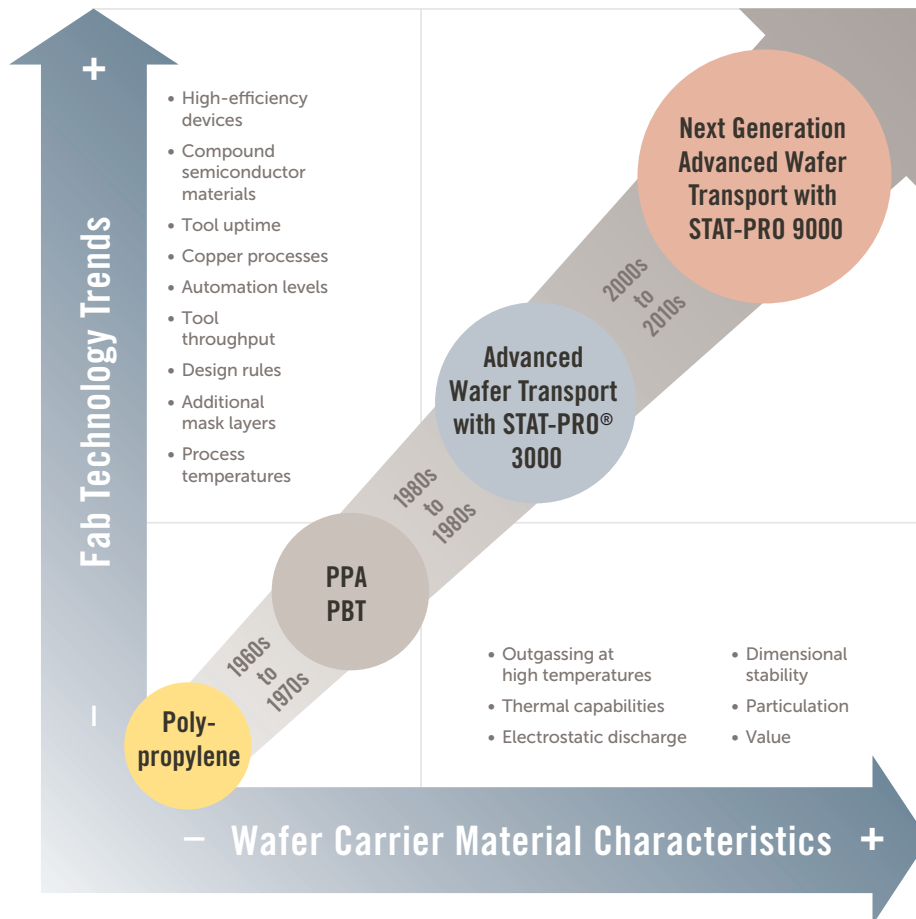

MULTIPLE WAFER SHIPPING BOXES

ULTRAPAK® SERIES

- Individual horizontal cantilever springs limit wafer rotation to reduce particle contamination and also secure the wafers in the cassette to safeguard against breakage
- Ultrapure polypropylene materials provide a clean shipping environment and assure low levels of condensable inorganics
- Horizontal and vertical robotic pickup flanges on the cassette allow convenient handling
- Center notch track alignment and “H” bar ensure accurate equipment interoperability both vertically and horizontally
- Three design options to accommodate varying wafer thickness

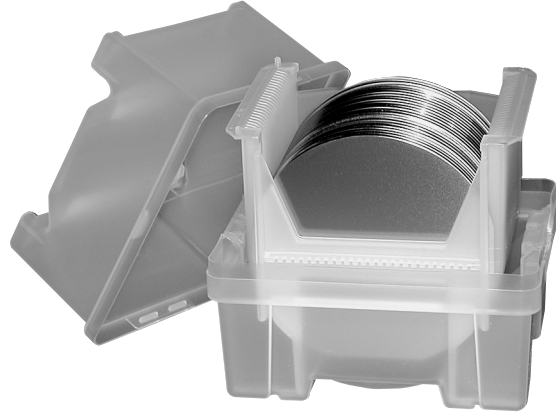

Ultrapak wafer shipping box

Ordering Information

Part number	Description	Wafer thickness range	Material
H9150-0042	Thin wafer shipper, uncleaned	150 – 675 μ	High-purity polypropylene
H9150-0043	Thin wafer shipper, cleaned	150 – 675 μ	High-purity polypropylene
H9150-0037	Standard wafer shipper, uncleaned	400 – 800 μ	High-purity polypropylene
H9150-0038	Standard wafer shipper, cleaned	400 – 800 μ	High-purity polypropylene
H9150-0044PA	Thick wafer shipper, uncleaned	500 – 1500 μ	High-purity polypropylene
H9150-0045PA	Thick wafer shipper, cleaned	500 – 1500 μ	High-purity polypropylene

SINGLE WAFER SHIPPING BOXES AND TRAYS

H93 SERIES SHIPPING BOX

- For shipping and storage applications
- Holds one wafer face down contacting only the wafer's edges
- Replaceable cushions securely retain the wafer to minimize particle generation
- Single latch provides secure closure and easy opening
- Tweezer slots conveniently located for easy wafer handling
- Large top surface provides a convenient space for labeling
- Stackable shipping boxes allow efficient use of storage space
- Pin-in-socket hinges allow the shipper to be opened horizontally, providing stability for wafer handling
- Clear polycarbonate material allows visual inspection without opening
- Optional STAT-PRO® 500 black conductive polycarbonate material provides static protection
- Overall size: 175 mm × 160 mm × 20 mm (6.9" × 6.3" × 0.8")



H93 single wafer shipper

Ordering Information

Part number	Description	Material
H93-60-101-1116	Assembly	Clear polycarbonate
H93-60-101-66C02	Assembly, ESD	STAT-PRO 150

SOLOPAK® SERIES SHIPPING BOX

- For shipping and storage applications
- Holds one wafer face down or face up in a conical pocket contacting only the wafer's edges
- Flat or notch locators prevent wafer rotation to minimize particle generation
- Dual latch provides secure closure and easy opening
- Tweezer slots conveniently located for easy wafer handling
- Large top surface provides a convenient space for labeling
- Stackable shipping boxes allow efficient use of storage space
- Pin-in-socket hinges allow the shipper to be opened horizontally, providing stability for wafer handling
- Clear polycarbonate material allows visual inspection without opening
- Overall size: 173 mm x 162 mm x 16 mm (6.8" x 6.4" x 0.6")



Solopak single wafer shipper

Ordering Information

Part number	Description	Material
Z150-0101	Shipping box for flat wafer	Clear polycarbonate

H22 SERIES SHIPPING BOX

- For shipping and storage applications
- Holds one wafer face down in a conical pocket contacting only the wafer's edges
- Spring securely retains the wafer to minimize particle generation
- Screw on cover provides secure closure and easy opening
- Large top surface provides a convenient space for labeling
- Stackable shipping boxes allow efficient use of storage space



H22 single wafer shipping box

- Natural polypropylene or STAT-PRO 150 black conductive polypropylene material for static protection
- Overall size: 164 mm dia. x 20 mm (6.5" dia. x 0.8")

Ordering Information

Part number	Description	Material
H22-60-0615 H22-60-62C02	Tray	Natural polypropylene STAT-PRO 150
H22-601-0615 H22-601-62C02	Cover	Natural polypropylene STAT-PRO 150
H22-602-0615 H22-602-62C02	Spring	Natural polypropylene STAT-PRO 150

H20 SERIES TRAY

- For internal handling and storage applications
- Holds one wafer face down in a conical pocket contacting only the wafer's edges
- Tweezer slots conveniently located for easy wafer handling
- Stackable tray on tray for efficient use of storage space
- Overall size:
 - H20-5000: 163 mm x 163 mm x 5 mm (6.4" x 6.4" x 0.2")
 - H20-5001: 163 mm x 163 mm x 10 mm (6.4" x 6.4" x 0.4")

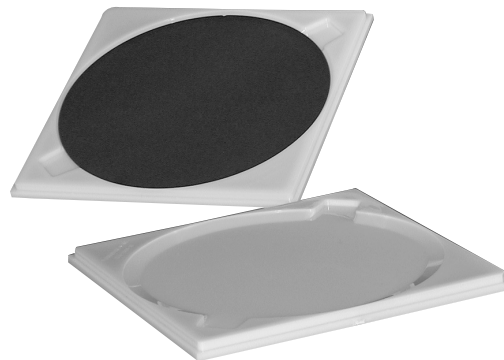

H20 single wafer trays

Ordering Information

Part number	Description	Material
H20-5000-01-1415*	Tray, pocket depth 1.5 mm (0.06")	Natural ABS
H20-5001-01-1415*	Tray, pocket depth 1.3 mm (0.05")	Natural ABS

*Extended lead times and minimum order quantities apply.

TRANSPORT WAFER CARRIERS

194/196 SERIES

SUPERIOR AUTOMATION PERFORMANCE

- High rigidity and dimensional stability
- Four-point contact on the "H" bar and track for improved wafer positioning
- Open sidewall style
- High profile design for maximum wafer protection
- Locating track notches for the center of the thirteenth pocket
- "H" bar equipment interface
- Pins and holes on the top rail
- Wafer capacity: 25
- D1 dimension: 14.5 mm (0.57")
- Pocket spacing: 4.8 mm (0.19")
- Pocket flat: 1.5 mm (0.06")

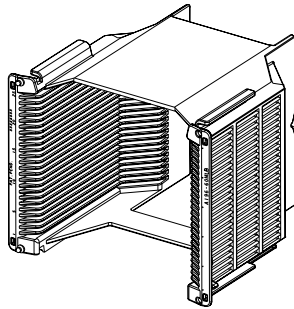

K196-60MLB-97C02

182 SERIES

THE INDUSTRY STANDARD 150 MM WAFER CARRIER

- High rigidity and dimensional stability
- Four-point contact on the "H" bar and track for improved wafer positioning (unless noted)
- Open sidewall style
- High profile design for maximum wafer protection
- Locating track notches for the center of the thirteenth pocket (unless noted)
- "H" bar equipment interface
- Pins and holes on the top rail
- Wafer capacity: 25
- D1 dimension: 14.5 mm (0.57")
- Pocket spacing: 4.8 mm (0.19")
- Pocket flat: 1.5 mm (0.06")

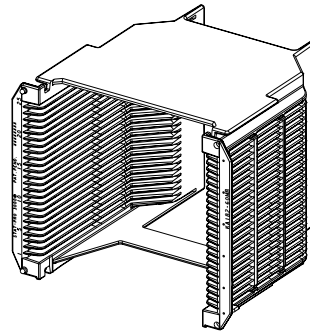

K182-60MB-97C02

Next generation advanced wafer transport carriers shown in **bold blue**.

Advanced wafer transport carriers shown in **bold**.

Ordering Information

Part number	End wall configuration	"H" bar end flanges	Compatible boxes	Material	Notes
K196-60MLB-97C02	Flanges	Yes	E90, E124, E160, E206, H3150	STAT-PRO 9000	—
K196-60ML-97C02	Flanges	No	E90, E124, E160, E206, H3150	STAT-PRO 9000	—
A196-60MLB-47C02	Flanges	Yes	E90, E124, E160, E206, H3150	STAT-PRO 3000	Allows migration to K196-60MLB-97C02
A196-60ML-47C02	Flanges	No	E90, E124, E160, E206, H3150	STAT-PRO 3000	Allows migration to K196-60ML-97C02
A196-60MLX-47C02	Flanges, handle	Yes	—	STAT-PRO 3000	—
FA196B-60MLB-7902	Flanges	Yes	E90, E124, E160, E206, H3150	FluoroSentry	Allows migration to A196-60MLB-47C02 or K196-60MLB-97C02
PA194-60MB-0603	Flanges	Yes	E90, E124, E160, E206, H3150	Blue polypropylene	Red, green, yellow, orange, and natural colors available
PA194-60MB-61C02	Flanges	Yes	E90, E124, E160, E206, H3150	STAT-PRO 100	
K182-60MB-97C02	Flanges	No	E90, E124, E160, E206, H3150	STAT-PRO 9000	No track notches (version with notches available – contact Entegris)
KA182-60MB-47C02	Flanges	No	E90, E124, E160, E206, H3150	STAT-PRO 3000	No track notches (version with notches available – contact Entegris) Allows migration to K182-60MB-97C02
FA182-60MB-7902	Flanges	No	E90, E124, E160, E206, H3150	FluoroSentry	Allows migration to KA182-60MB-47C02 or K182-60MB-97C02
PA182-60MB-0603	Flanges	No	E90, E124, E160, E206, H3150	Blue polypropylene	No four-point contact No track notches Allows migration to KA182-60MB-47C02 or K182-60MB-97C02 Red, green, yellow, orange, and natural colors available
PA182-60MB-61C02	Flanges	No	E90, E124, E160, E206, H3150	STAT-PRO 100	No four-point contact No track notches Allows migration to FA182-60MB-7902, KA182-60MB-47C02 or K182-60MB-97C02
PA182-60MC-61C02	Flanges, inspection window	No	E90, E124, E160, E206, H3150	STAT-PRO 100	No four-point contact No track notches
PA182-60MBN-61C02	Flanges	No	E90, E124, E160, E206, H3150	STAT-PRO 100	No four-point contact Allows migration to KA182-60MB-47C02 or K182-60MB-97C02

PROCESS WAFER CARRIERS

194 SERIES

SUPERIOR PROCESS CARRIER AUTOMATION PERFORMANCE

- Improved process carrier rigidity and dimensional stability
- Four-point contact on the "H" bar and track for improved wafer positioning
- Open sidewall design to minimize liquid traps and promote even solution coverage and drainage
- High profile design for maximum wafer protection
- Locating track notches for the center of the thirteenth pocket
- "H" bar equipment interface
- Pins and holes on the top rail
- Chemical resistant natural PFA material
- Wafer capacity: 25
- D1 dimension: 14.5 mm (0.57")
- Pocket spacing: 4.8 mm (0.19")
- Pocket flat: 1.5 mm (0.06")

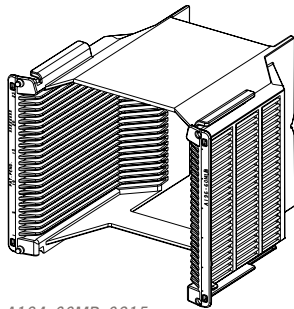

A194-60MB-0215

190 SERIES

LOW PROFILE FOR OPTIMUM PERFORMANCE IN CENTRIFUGAL APPLICATIONS

- Low contour for improved spray penetration to the wafers
- Open sidewall design to minimize liquid traps and promote even solution coverage and drainage
- "H" bar equipment interface
- Pins and holes on the top rail
- Chemical resistant natural PFA material
- Wafer capacity: 25
- D1 dimension: 14.5 mm (0.57")
- Pocket spacing: 4.8 mm (0.19")
- Pocket flat: 1.4 mm (0.05")

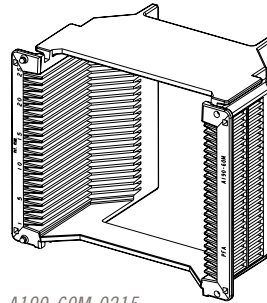

A190-60M-0215

182 SERIES**THE INDUSTRY STANDARD 150 MM PROCESS
WAFER CARRIER**

- Four-point contact on the "H" bar for improved wafer positioning
- Open sidewall design to minimize liquid traps and promote even solution coverage and drainage
- High profile design for maximum wafer protection
- "H" bar equipment interface
- Pins and holes on the top rail
- Chemical resistant natural PFA material
- Wafer capacity: 25
- D1 dimension: 14.5 mm (0.57")
- Pocket spacing: 4.8 mm (0.19")
- Pocket flat: 1.5 mm (0.06")

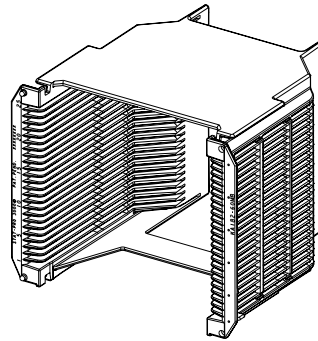

A182-60MB-0215

Ordering Information

Part number	End wall configuration	"H" bar end flanges	Compatible boxes	Compatible boxes	Material
A194-60MB-0215	Flanges	Yes	E90, E124, E160, E206, H3150	A72-60-03, A040-103, A049, A72-60-04, A055	Natural PFA
A190-60M-0215	Flanges	No	E124, E160, H3150	A72-60-03, A055	Natural PFA
A190-60MH-0215	Flanges, handle	No	H3150	A72-60-03	Natural PFA
A182-60M-0215	—	No	E90, E124, E160, E206, H3150	A72-60-03, A040-103, A049, A72-60-04	Natural PFA
A182-60MB-0215	Flanges	No	E90, E124, E160, E206, H3150	A72-60-03, A040-103, A049, A72-60-04, A055	Natural PFA
A182-60MBH-0215	Handle, flanges	No	—	A72-60-03, A040-103, A049, A72-60-04	Natural PFA
A182-60MC-0215	Flanges, inspection window	No	E90, E124, E160, E206, H3150	A72-60-03, A040-103, A049, A72-60-04, A055	Natural PFA
A182-60MU-0215 end wall	Flanges, "U"	Yes	E90, E124, E160, E206, H3150	A72-60-03, A040-103, A049, A72-60-04	Natural PFA

STORAGE BOXES

E160 SERIES

OPTIMUM PERFORMANCE AND REDUCED PARTICLE GENERATION

- Five degree wafer tilt from wafers vertical allows wafers to rest on their backsides, reducing movement and particle generation
- Smooth surfaces for easy cleaning and low particle generation
- Pin and socket hinges with retainers for improved durability
- Stackable
- Single carrier capacity
- Compatible carriers: All 25-capacity without handles
- Overall dimensions: 195 mm × 203 mm × 211 mm (7.7" × 8.0" × 8.3")

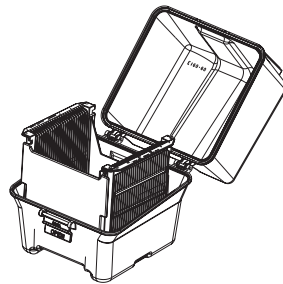

E160-60-103-69F02 box with K182-60MB-97C02 carrier

E124 SERIES

THE INDUSTRY STANDARD 150 MM STORAGE BOX

- Automation compatible
- Smooth surfaces for easy cleaning and low particle generation
- Drop front allows easy access by robotic end effectors
- Robotic compatible slide latch
- Rotating pin and socket hinges prevent box from tipping when open
- Stackable
- Single carrier capacity
- Compatible carriers: All 25-capacity without handles
- Overall dimensions: 213 mm × 213 mm × 190 mm (8.4" × 8.4" × 7.5")

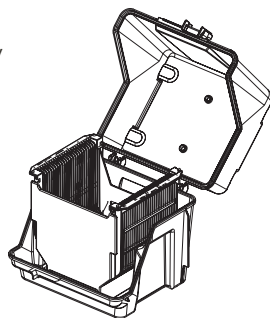

E124-60-101-69F02 box with K182-60MB-97C02 carrier

E90 SERIES

MAXIMUM STACKING DENSITY FOR SPACE LIMITED STOCKERS AND WIP RACKS

- Smooth bottom
- Pin and socket hinges
- Stackable
- Single carrier capacity
- Compatible carriers: 182 series and 194/196 series 25-capacity without handles
- Overall dimensions: 208 mm × 193 mm × 188 mm (8.2" × 7.6" × 7.4")

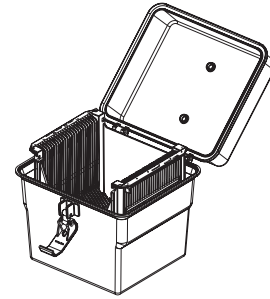

E90-102-61C02 box with K182-60MB-97C02 carrier

E206 SERIES

REDUCED PARTICLE GENERATION AND ENHANCED ROBOTIC INTERFACE

- Automation compatible
- Twenty degree wafer tilt from wafers horizontal allows wafers to rest on their backsides, reducing movement and particle generation
- Smooth surfaces for easy cleaning and low particle generation
- Keyed pin and socket hinges are free rotating and easy to assemble and disassemble
- Stackable
- Single carrier capacity
- Compatible carriers: All 25-capacity without handles except A190 series low profile process carriers
- Overall dimensions: 439 mm × 274 mm × 216 mm (17.3" × 10.8" × 8.5")

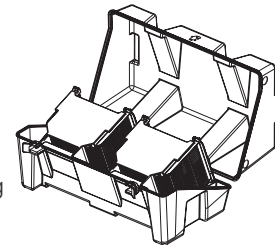

E206-60-101-69F02 box with K182-60MB-97C02 carrier

H3150 SERIES

Optimum Performance and High Storage Density

- Five degree wafer tilt from wafers vertical (unless noted) allows wafers to rest on their backsides, reducing movement and particle generation
- Smooth surfaces for easy cleaning and low particle generation
- Low profile base allows easy access to wafer carrier end wall flanges
- Rotating pin and socket hinges prevent box from tipping when open
- Stackable (unless noted)
- Two carrier capacity
- Compatible carriers: All 25-capacity without handles
- Overall dimensions: 211 mm x 405 mm x 189 mm (8.3" x 16.0" x 7.43")



H3150-0001 box with two K182-60MB-97C02 carriers

Ordering Information

Part number	Latch style	Compatible envelope	Optional cushion	Material	Notes
E160-60-103-69F02	Flip	—	—	STAT-PRO 175	Molded in cardholder
E160-60-103S-69F02	Flip	E96-21-1613	—	STAT-PRO 175	Molded in cardholder
E160-60-103-69F16	Flip	—	—	Cover: clear polycarbonate Bottom: STAT-PRO 175	Molded in cardholder Red, blue and green polycarbonate covers available
E124-60-101-0603	Slide	E96-3P-21A15	E95-6-0815	Blue polypropylene	Molded in cardholder Red, green, yellow, orange and natural colors available
E124-60-101-61C02	Slide	E96-3P-21A15	E95-6-0815	STAT-PRO 100	Molded in cardholder
E124-60-101-69F02	Slide	E96-3P-21A15	E95-6-0815	STAT-PRO 175	Molded in cardholder
E124-60-103-69F16	Slide	E96-3P-21A15	E95-6-0815	Cover: clear polycarbonate Bottom: STAT-PRO 175	Molded in cardholder Red, blue and green polycarbonate covers available
E90-101-0603	Snap	E96-3P-21A15	E95-2-0815	Blue polypropylene	Red, green, yellow, orange and natural colors available
E90-101-61C02	Snap	E96-3P-21A15	E95-2-0815	STAT-PRO 100	—
E90-102-0603	Swing pin	E96-3P-21A15	E95-2-0815	Blue polypropylene	Red, green, yellow, orange and natural colors available
E90-102-61C02	Swing pin	E96-3P-21A15	E95-2-0815	STAT-PRO 100	—
E206-60-101-0603	Quarter turn	E96-4P-21A15	—	Blue polypropylene	Red, green, yellow, orange and natural colors available
E206-60-101-61C02	Quarter turn	E96-4P-21A15	—	STAT-PRO 100	—
E206-60-101-69F02	Quarter turn	E96-4P-21A15	—	STAT-PRO 175	—
H3150-0001	Flip	—	—	STAT-PRO 100	Two molded in cardholders Stackable – no wafer tilt
H3150-0015	Flip	—	—	EmstatAR	Two molded in cardholders Stackable – no wafer tilt

OPTIONS AND ACCESSORIES

WAFER CARRIER HANDLES

Entegris offers a variety of wafer carrier handles to meet your specific application requirements.

Ordering Information

Part number	Handle style	Description	Compatible wafer carriers	Overall size	Material
A72-60-03-0215 PA72-60-03-0603	Squeeze	Attaches to the notches on both end walls of carrier	All "M" style	163 mm x 140 mm x 183 mm (6.4" x 5.5" x 7.2")	Natural PFA Blue polypropylene
A040-103-0215	Squeeze with lock bar	Attaches to the notches on both end walls of carrier	All 182 series and 194 series	165 mm x 152 mm x 165 mm (6.5" x 6.0" x 6.5")	Natural PFA
A049-0215	Squeeze with support bar	Attaches to the notches on both end walls of carrier	All 182 series and 194 series	165 mm x 163 mm x 203 mm (6.5" x 6.3" x 8.0")	Natural PFA
A72-60-04-0215 PA72-60-04-0603	Slingshot	Slides onto the top flanges of the carrier	All 182 series and 194 series	15 mm x 192 mm x 237 mm (0.6" x 7.5" x 9.3")	Natural PFA Blue polypropylene
A055-0215	End-load	Attaches to the flanges on the end wall of the carrier, allowing handling of carrier from end rather than over the top	All carriers with robotic flanges except those with end wall handles or "U" end walls	208 mm x 173 mm x 46 mm (8.2" x 6.8" x 1.8")	Natural PFA



Squeeze style



Squeeze style with lock bar



Squeeze style with lock bar



Slingshot style

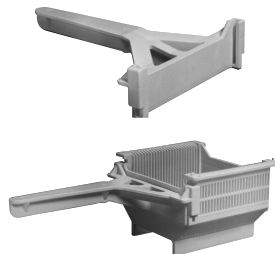

End-load style

STORAGE BOX ACCESSORIES

TRAVELER ENVELOPES

- Flexible envelopes snap onto covers
- Compatible with most 150 mm storage boxes

Ordering Information

Part number	Compatible	Material
E96-3P-21A15	E90 series and E124 series	Antistatic PVC
E96-4P-21A15	E206 series	Antistatic PVC
E96-21-1613	Select E160 series	Transparent PVC

CUSHIONS

- Snap inside box covers to provide added wafer security
- Compatible with E90 series and E124 series storage boxes

Ordering Information

Part number	Compatible storage boxes	Material
E95-2-0815	E90 series	Low-density polyethylene
E95-6-0815	E124 series	Low-density polyethylene



E160-60-103S-69F02 box with E96-21-1613 attached

IDENTIFICATION OPTIONS

Entegris offers various identification options including:

- Laser marking
- Hot stamping
- Bar code labels
- Radio frequency tags
- Cardholders
- Booklet holders
- Run card slip
- Colored ID tags

Contact Entegris to determine a suitable identification method for your application.

MATERIAL INFORMATION

General material information is provided for your reference. Contact Entegris for additional information.

Material	Application	Description	Surface resistivity (ohms/sq)	Continuous use temperature limit	Wafer insertion temperature limit
Blue polypropylene	Standard storage box material	Natural polypropylene with a blue colorant	—	55°C	—
EmstatAR	High-performance storage	A static dissipative blend of polypropylene box material and carbon fiber	$10^5 - 10^9$	55°C	—
FluroSentry	Intermediate-performance wafer transport carrier material	An advanced, static protective blend of butyl terephthalate (PBT) and carbon fiber	$10^4 - 10^{10}$	55°C	55°C
High-purity polypropylene	Multiple wafer shipping box material	Ultrapure natural polypropylene	—	55°C	—
Natural ABS	Tray material	Opaque acrylonitrile butadiene styrene (ABS)	—	70°C	—
Natural PFA	Process wafer carrier material	Translucent perfluoroalkoxy	—	180°C	290°C
Polycarbonate	Transparent storage box cover material	Colorable, transparent material	—	55°C	—
STAT-PRO 100	Wafer transport carrier and storage box material	A static dissipative blend polypropylene, and pure inert carbon powder	$10^3 - 10^8$	55°C	55°C
STAT-PRO 150	Single wafer shipping box material	A conductive blend of polypropylene, glass bead, and carbon powder	$10^1 - 10^5$	55°C	—
STAT-PRO 175	High-performance storage box material	A static dissipative blend of polypropylene and carbon fiber	$10^5 - 10^9$	55°C	—
STAT-PRO 500	Single wafer shipping box material	A conductive blend of polycarbonate and carbon fiber	$10^3 - 10^6$	55°C	—
STAT-PRO 3000	High-performance wafer transport carrier material	An advanced, static dissipative blend of polyetheretherketone and carbon fiber	$10^4 - 10^9$	120°C	340°C
STAT-PRO 9000	Next generation, high-performance wafer transport carrier material	An advanced, static dissipative blend of carbon nanotube (CNT) enhanced polyetheretherketone (PEEK™ polymer) carbon compound	$10^4 - 10^6$	120°C	340°C

OTHER PRODUCTS

Additional products and services to support your 150 mm wafer processing needs include:

- Mask and reticle packages
- Finished wafer shipping products
- Bare die and packaged IC shipping and handling products

LIMITED WARRANTY

Entegris' products are subject to the Entegris, Inc. General Limited Warranty. To view and print this information, visit entegris.com and select the [Legal & Trademark Notices](#) link in the footer. Entegris does not warrant any failure in the case of customers using unapproved foreign components.

FOR MORE INFORMATION

Please call your Regional Customer Service Center today to learn what Entegris can do for you. Visit entegris.com and select the [Contact Us](#) link to find the customer service center nearest you.

TERMS AND CONDITIONS OF SALE

All purchases are subject to Entegris' Terms and Conditions of Sale. To view and print this information, visit entegris.com and select the [Terms & Conditions](#) link in the footer.



Corporate Headquarters

129 Concord Road
Billerica, MA 01821
USA

Customer Service

Tel +1 952 556 4181
Fax +1 952 556 8022
Toll Free 800 394 4083

Entegris®, the Entegris Rings Design®, and other product names are trademarks of Entegris, Inc. as listed on entegris.com/trademarks. All third-party product names, logos, and company names are trademarks or registered trademarks of their respective owners. Use of them does not imply any affiliation, sponsorship, or endorsement by the trademark owner.

©2002-2020 Entegris, Inc. | All rights reserved. | Printed in the USA | 1110-5668ENT-0920